

MONTÁŽNÍ NÁVOD	PŘISAZENÁ SVÍTIDLA SE SKLAPOVACÍMI DRŽÁKY	
INSTALLATION INSTRUCTIONS	SURFACE MOUNTED LIGHTS WITH FOLDING HOLDERS	
MONTAGEANLEITUNG	AUFBAULEUCHTEN MIT KLAPPBARER HALTERUNG	

<p><b>Elektrická instalace a bezpečnost:</b>  <b>Electrical installation and safety:</b>  <b>Elektroinstallation und Sicherheit:</b></p> 	<p>Obecně je nutno dbát platných norem EU. Při jakékoliv revizní či servisní činnosti je nutno svítidlo odpojit od elektrické sítě. Práce smí provádět pouze pracovník s odbornou kvalifikací.  <b>POZOR</b> při manipulaci s LED modulem a přívodními kabely k LED modulu! <b>Nedotýkat se LED diod!</b></p>
	<p>Generally it is necessary to follow the EU regulations. At any revision or service activity it is necessary to disconnect lighting fitting from the electrical network. Only qualified and experienced person must do this work. <b>CAUTION</b> when handling the LED module and feeder cables connected to the LED module! <b>Do not touch the LEDs!</b></p>
	<p>Geltende EU-Normen sind zu beachten. Bei jeglichen Revisions- und Servicetätigkeiten muss die Leuchte vom Stromnetz abgeklemmt werden. Solche Arbeiten dürfen nur von qualifizierten Fachkräften durchgeführt werden. <b>ACHTUNG:</b> Umgang mit den LED-Modulen und Nutzung der Kabel im LED-Modul! <b>Berühren Sie nicht die LED!</b></p>

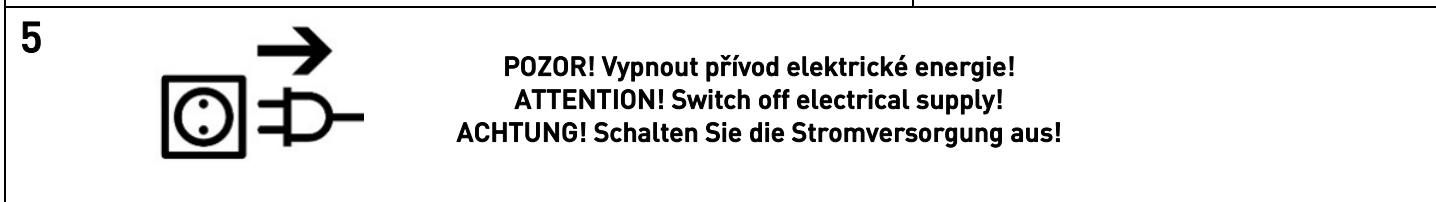
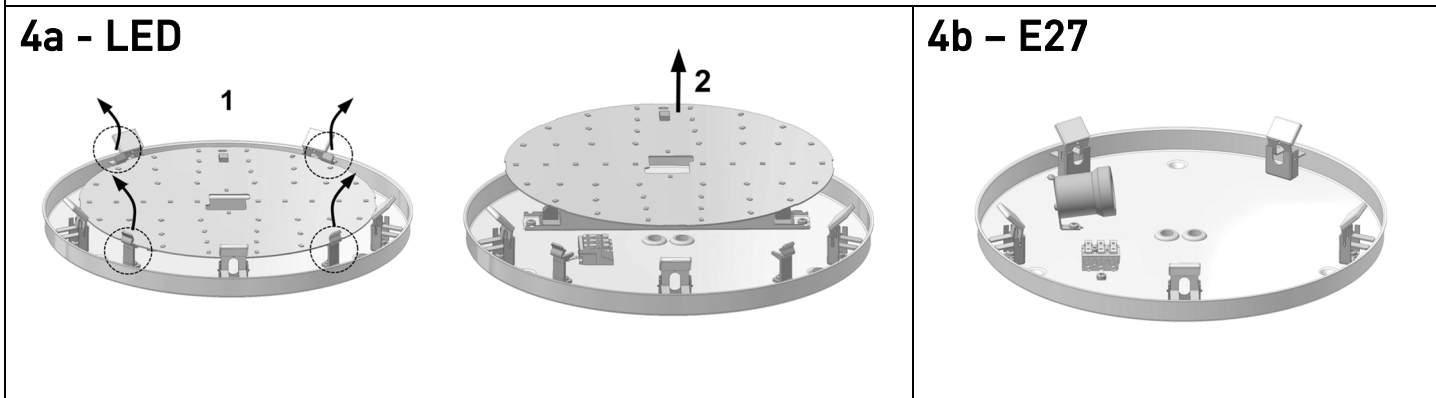
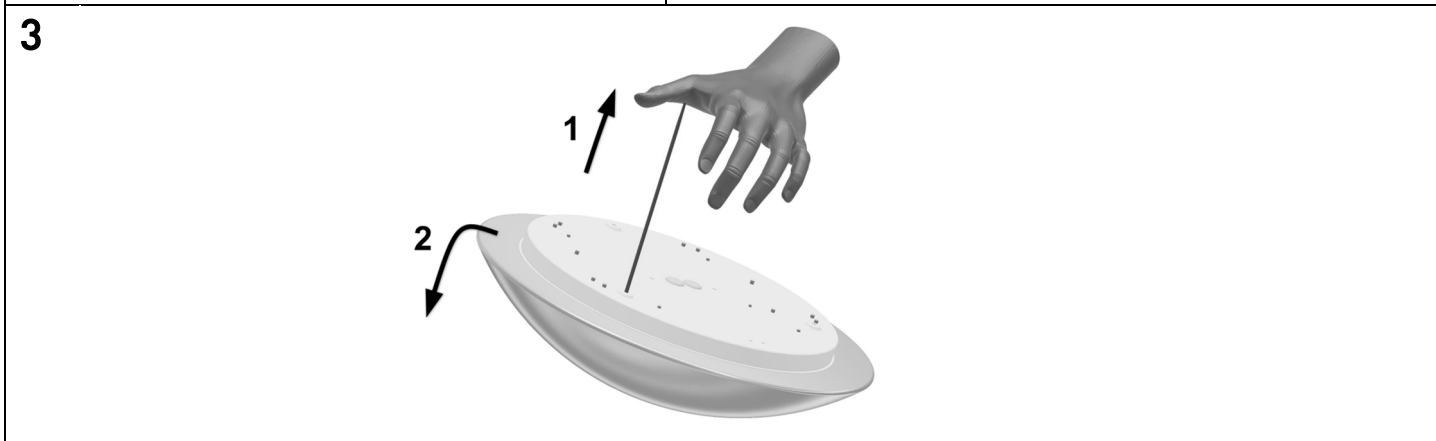
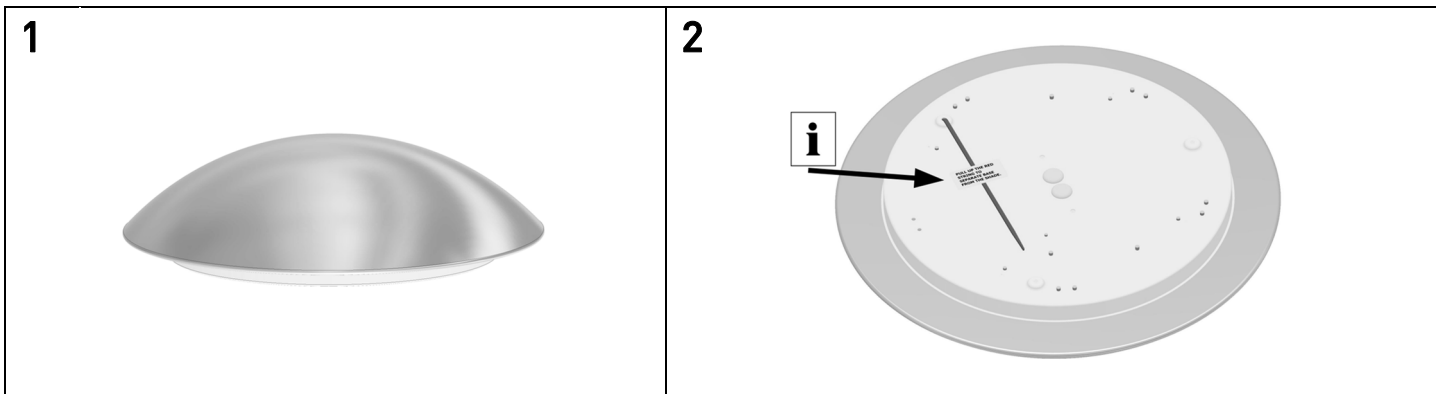

**6**

V případě použití dekorativního límce je nutné límec montovat společně s monturou. Límec je držen monturou, nikoliv za stínidlo.

If a decorative collar is used, the collar must be mounted together with the frame. The collar is held by the mount, not by the shade.

Bei Verwendung eines Zierkragens wird der Kragen angelegt zusammen mit dem Schatten. Nicht durch eine Vorrichtung gehalten.

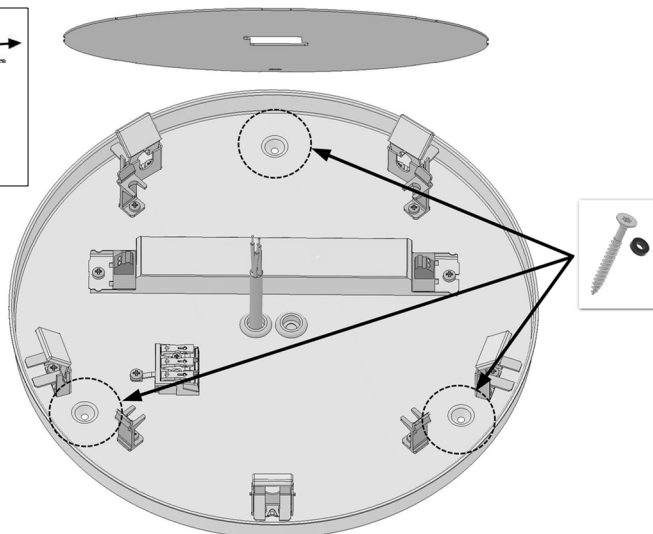
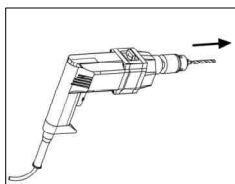

**7**

Zapojení elektroinstalace svítidla.  
Connection of power supply to the luminaire.  
Anschluss der Stromversorgung an die Leuchte.

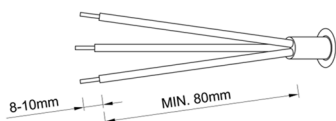

ON/OFF

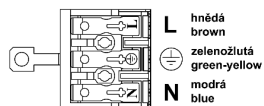

STMÍVATELNÉ  
DIMMABLE DALI

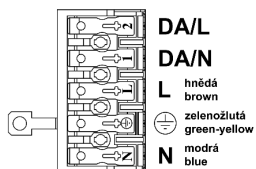

OVLÁDÁNÍ TLAČÍTKEM  
SWITCH DIM

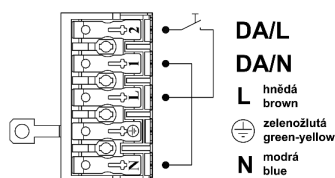

NOUZOVÉ  
EMERGENCY

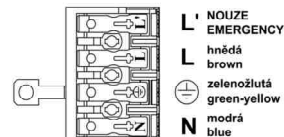

**8a - LED**

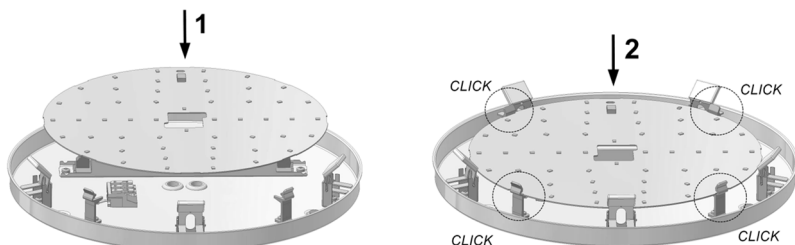

**8b - E27**

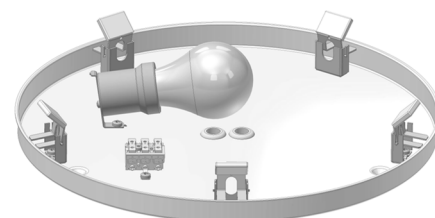

**9**

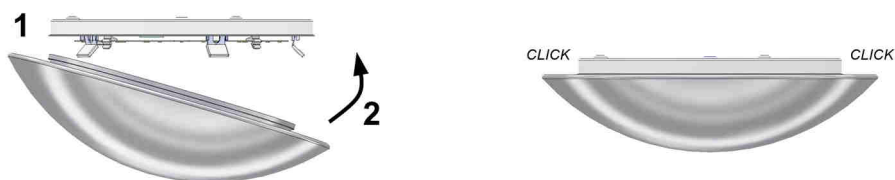

**10**

