

Elektrická instalace a bezpečnost:
Electrical installation and safety:
Elektroinstallation und Sicherheit:



Obecně je nutno dbát platných norem EU. Při jakékoliv revizní či servisní činnosti je nutno svítidlo odpojit od elektrické sítě. Práce smí provádět pouze pracovník s odbornou kvalifikací.

POZOR při manipulaci s LED modulem a přívodními kabely k LED modulu! **Nedotýkat se LED diod!**

Generally it is necessary to follow the EU regulations. At any revision or service activity it is necessary to disconnect lighting fitting from the electrical network. Only qualified and experienced person must do this work. **CAUTION** when handling the LED module and feeder cables connected to the LED module! **Do not touch the LEDs!**

Geltende EU-Normen sind zu beachten. Bei jeglichen Revisions- und Servicetätigkeiten muss die Leuchte vom Stromnetz abgeklemmt werden. Solche Arbeiten dürfen nur von qualifizierten Fachkräften durchgeführt werden. **ACHTUNG:** Umgang mit den LED-Modulen und Nutzung der Kabel im LED-Modul! **Berühren Sie nicht die LED!**

1

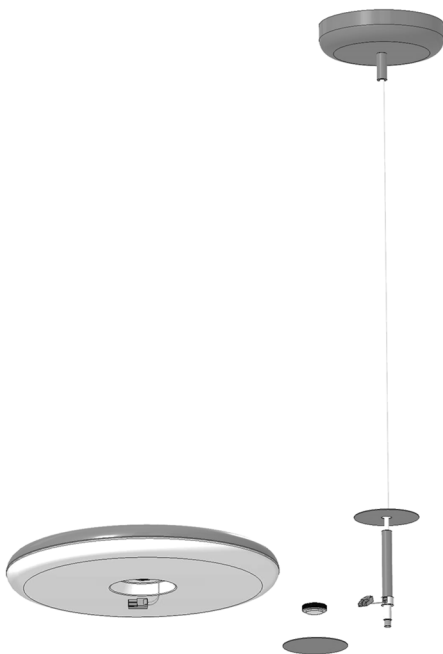

2

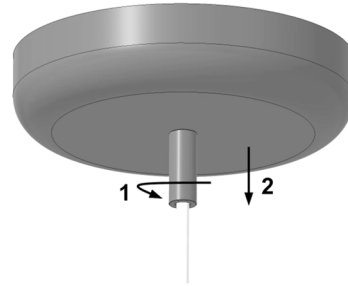

3

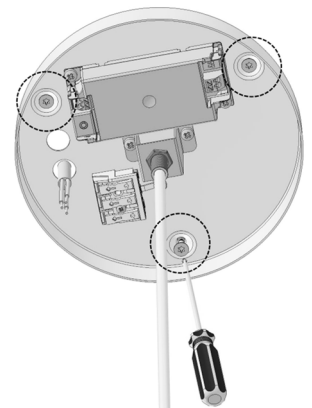
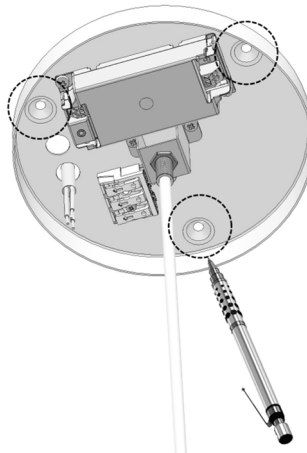

2

POZOR!
Vypnout přívod elektrické energie!

ATTENTION!
Switch off electrical supply!



ACHTUNG!
Schalten Sie die Stromversorgung aus!

4

Zapojení elektroinstalace svítidla.
 Connection of power supply to the luminaire.
 Anschluss der Stromversorgung an die Leuchte.

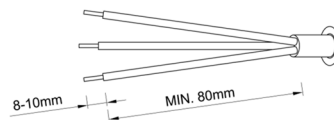

ON/OFF

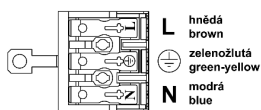
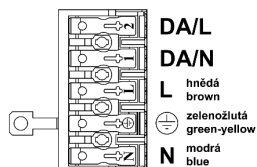
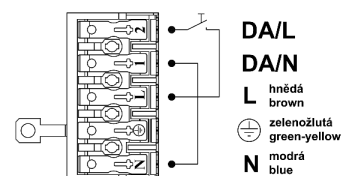
STMÍVATELNÉ
DIMMABLE DALIOVLÁDÁNÍ TLAČÍTKEM
SWITCH DIM

5



PŘÍMÉ SVÍCENÍ
DIRECT LIGHTING
DIREKTE BELEUCHTUNG



NEPŘÍMÉ SVÍCENÍ
INDIRECT LIGHTING
INDIREKT BELEUCHTUNG

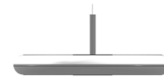

6a

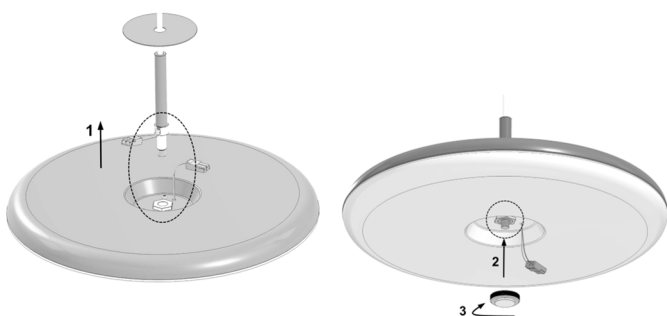

6b

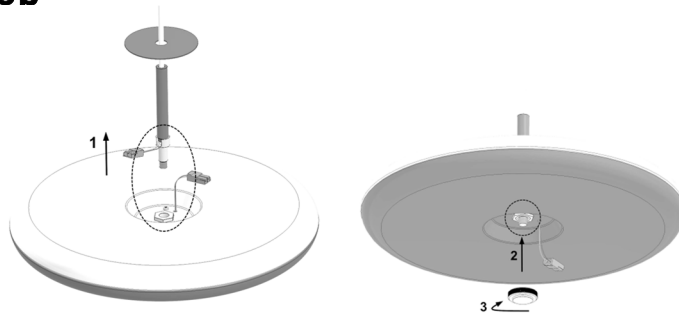

8a



8b

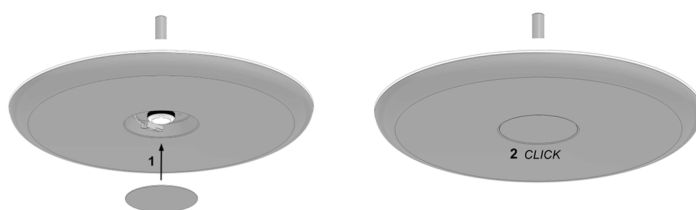

9a

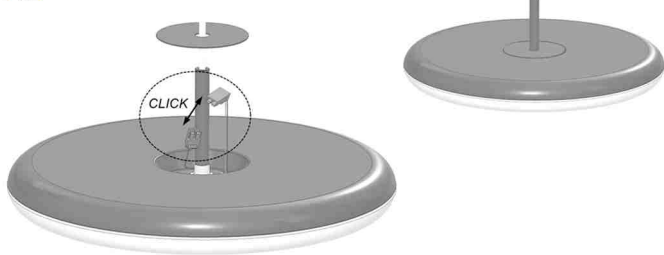

9b

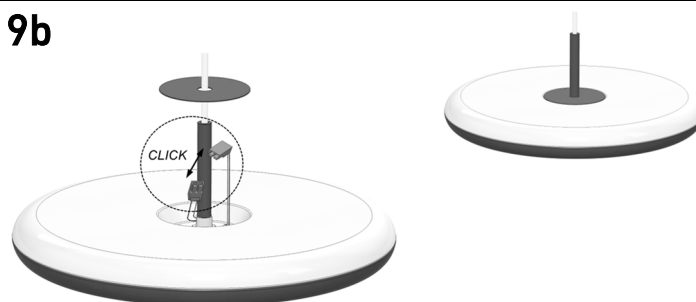

10a



10b

